

MULTI-FIT FRONT BASKET

- Fits 7/8", 1" & 1-1/4" Diameter Bars
- Comes with metric fasteners
- 2-Piece adjustable legs

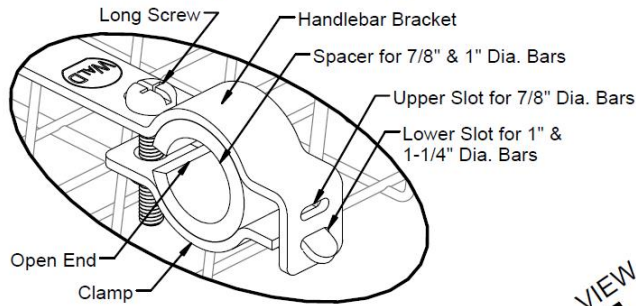

VIEW A

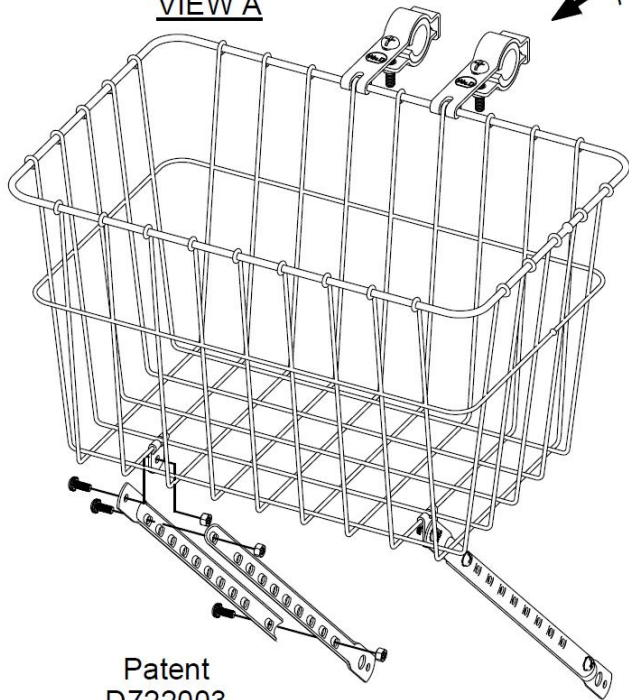

Patent
D722003

ASSEMBLY
INSTRUCTIONS
ON BACK



Proudly Made in the U.S.A.

Mfgr.No.198GB (Black)
©2015 Wald LLC
Rev.D, 2/27/2015



WARNING : This product contains a chemical known to the state of California to cause cancer.

Assembly Instructions :

IMPORTANT :

- Use wrench & screwdriver to fully tighten all nuts & screws

- Fasten basket to handlebar with clamps using larger diameter long screws. Loosely tighten.
 - If mounting to a 7/8" handlebar use the upper slot on the handlebar bracket and if to a 1" or 1-3/4" handlebar, use the lower slot.
 - If clamping onto 7/8" or 1" portion of handlebar, insert rubber spacer as shown in View A with open end towards screw.
- Attach top leg sections (marked "WALD") to leg mounting brackets on bottom of basket with small diameter screws & hex nuts. Loosely tighten.
- Adjust legs to the required length so top of basket is fairly level. Put the top leg to the outside & connect top & bottom legs together with smaller diameter screws & hex nuts (as shown).

Note: Use end hole of each leg section & align with adjusting hole in mating leg section. Insert screws through outside of leg with nuts on inside.
- When mounting basket legs to axle, install one leg at a time.
 - Remove axle nut from one side of wheel.
 - Place axle mounting hole (larger hole) on axle.
 - Replace axle nut & tighten.
 - Repeat steps 4A thru 4C for other side.
 - Be sure wheel is aligned properly in fork. If not, loosen axle nut(s), re-adjust & tighten.

Note: If bicycle has a quick-release front hub, see your bicycle dealer for attachment screws & proper mounting.
- Once legs are installed, adjust handlebar brackets so that basket does not rub tire or fender. Top of basket should be fairly level.
- Completely tighten all screws & nuts.

The following could result in loss of control & possible injury : failure to tighten basket screws & nuts, leg section screws & nuts, wheel axle nuts or failure to have wheel quick-release mechanism properly adjusted. Please consult a bicycle dealer or your bicycle owner's manual for applicable tightening/adjusting requirements. Note: Periodically check that all fasteners are tight.

⚠️WARNING!

- **DO NOT** overload basket. Overloading basket or not securing item(s) in basket may cause difficulty in steering and/or loss of bicycle control which could result in injury.
- **DO NOT** bend legs or leg mounting tabs.
- **DO NOT** mount legs to inside of the bicycle's front fork blades. Mount only to the outside of the bicycle's front fork blades.
- **DO NOT** assemble a quick-release front hub through leg holes. The legs are to be mounted to bolt on front axles or to fork eyelets.
- **DO NOT** use on bicycles with carbon fiber front fork or handlebar.
- **DO NOT** use on bicycles with a front suspension or springer fork.

